



EuropeanHome gas
fireplaces



timelessly clean & modern



Above: Gas Stones with White Cover

Front Cover: H Series See-Through, Taula House (TX). Designed by M Gooden Design.

Photography by Parrish Ruiz de Velasco

INDEX

H Series
single | corner | see-through |
3-sided | peninsula6-13

G Series
linear gas burner14-15

Gas Stones
modern gas log16-17

About..... 18

All models are designed and
manufactured in the U.S.A. 

“Quality is the pride
of workmanship”

– W. Edward Deming





designed by R+B Design Architecture, built by Wadleigh and Associates



H Series

This vent-free gas fireplace features a contemporary, trimless, open front style and is designed with simplicity in mind. The increasing desirability of vent-free gas fireplaces are growing in popularity for several reasons:

1. **Zero Clearance:** The term “zero clearance” means another layer of convenience and versatility. It allows the fireplace to be installed in close proximity to combustible materials such as walls, wood framing, or furniture without posing a hazard.
2. **Vent-Free Technology:** Without the need for complex venting systems, installation is straightforward, allowing for more flexible placement in homes and commercial spaces. This means vent-free options a more affordable choice for homeowners and builders.
3. **High Efficiency:** Vent-free gas fireplaces are known for their high efficiency. Since there’s no chimney or flue, heat is retained within the room,

making the fireplace 99% efficient. This translates to cost savings on your gas utility bills.

4. **Versatile Placement:** This installation flexibility makes vent-free fireplaces a convenient and attractive option for homeowners seeking to add warmth and style without the hassle of complex construction. This adds simplicity for multiple rooms, space-conscious homes, as well as renovations and remodels

The combination of ease of installation, energy efficiency, and contemporary style has made H Series vent-free fireplaces a popular choice in the market.

Above

H Series Single-Sided
Smith Campus Center
at Harvard University, MA

MODEL	H SERIES
Gas Type	Natural Gas (only)
Flame Adjustment	Yes
Vented Available	No
Vent-Free Available	Yes
Vented Flue Dimensions	N/A
Heat Output	25,000 - 37,500 BTU/hr (NG)
Efficiency	99% (Vent-Free)
Thermostatic Remote Control	Yes
Interior Options	Satin Black (Standard), Black Reflective or Concrete Style
Electronic Ignition	Yes
Certifications	ANSI Z21.11.2

H Series Single-Sided
 installer: Fireside Distributors, FL
 builder: Hedrick Brothers, FL

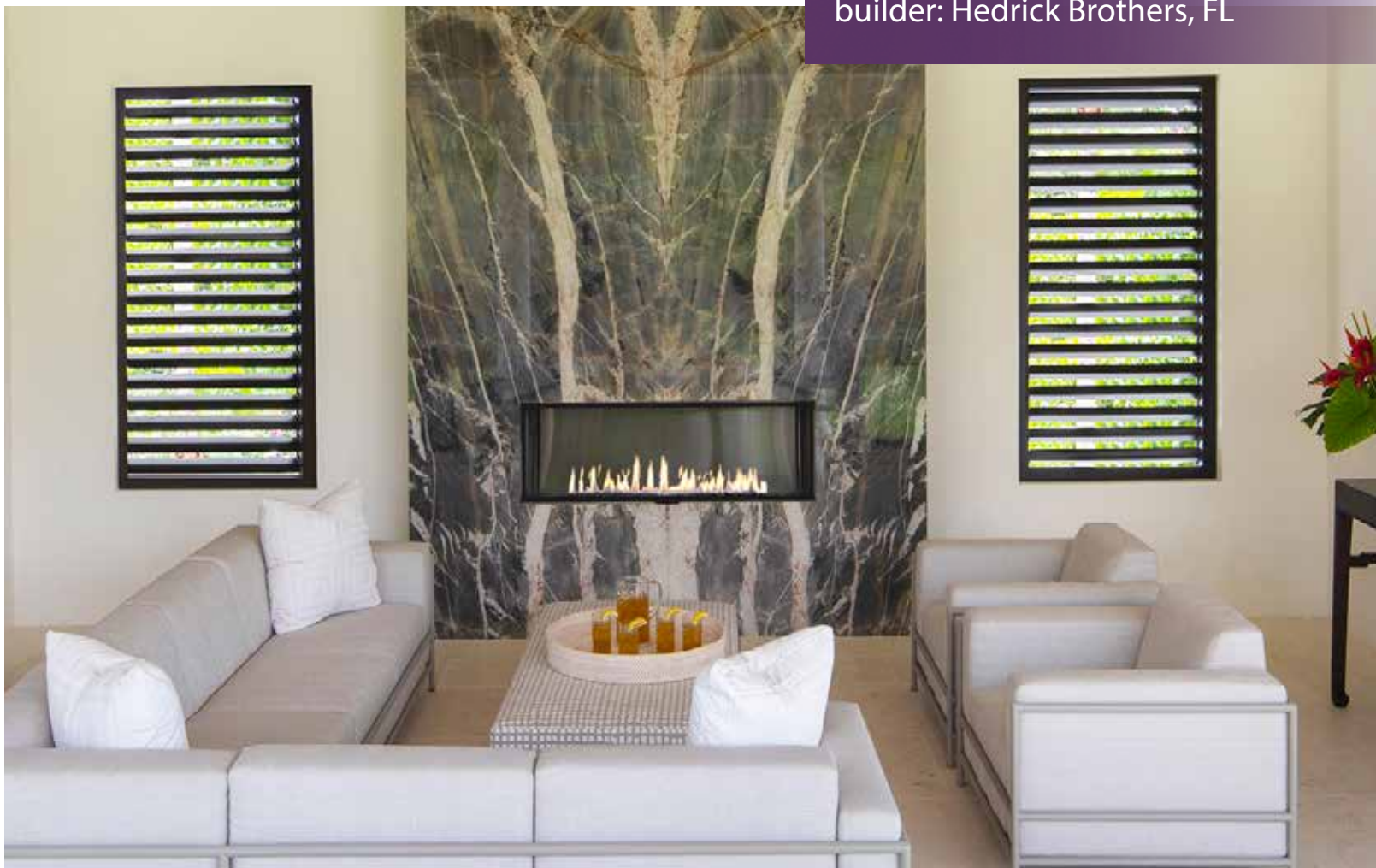

H Series: Design Options

1. UNIT SIZE OPTIONS



42"



60"



72"

2. CONFIGURATIONS

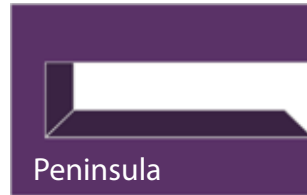
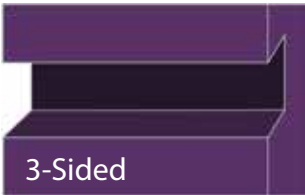
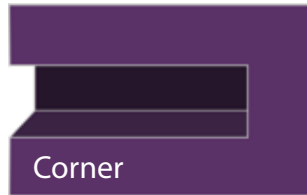
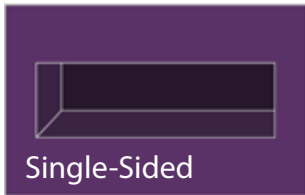

3. INTERIOR OPTIONS



Satin Black (Standard)



Concrete Style



Black Reflective

4. FIRE MEDIA



Pacific Blue Glass



Clear Glass



Amber Glass



Black Glass



Cobalt Blue Glass



Carrara Pebbles

H Series Peninsula

*Installed by
American Fireplace & BBQ Dist., MI*





HVF-42 [Single-Sided]
Pictured with optional Concrete Style interior.
Millennium Tower - Boston, MA



HVF-60 [Right Corner Style]
Pictured with Satin Black interior.



HVF-60 [See-Through]
Featured on HGTV's Love It or List It.
P.S. They Loved It!
Private Residence - Durham, NC

H Series

SINGLE-SIDED: DIMENSIONS (in.)

	HVF-42	HVF-60	HVF-72
A	42	60	72
B	18	18	18
C	18	18	18
D	37 1/2	37 1/2	37 1/2
E	38	49	59

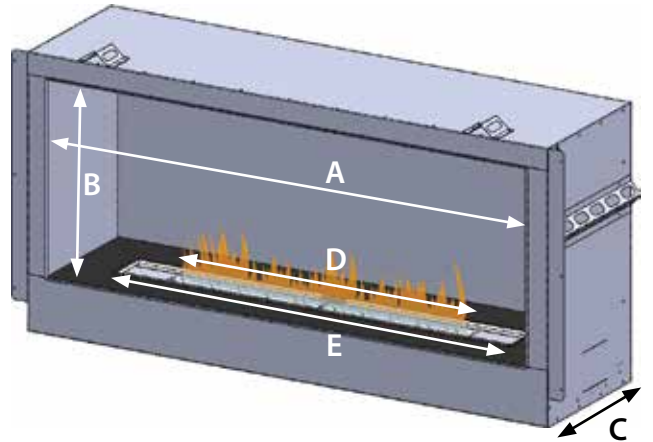

CORNER STYLE: DIMENSIONS (in.)

	HVF-42-C	HVF-60-C	HVF-72-C
A	44 1/2	62 3/4	74 1/2
B	18	18	18
C	18	18	18
D	37 1/2	37 1/2	37 1/2
E	38	49	59

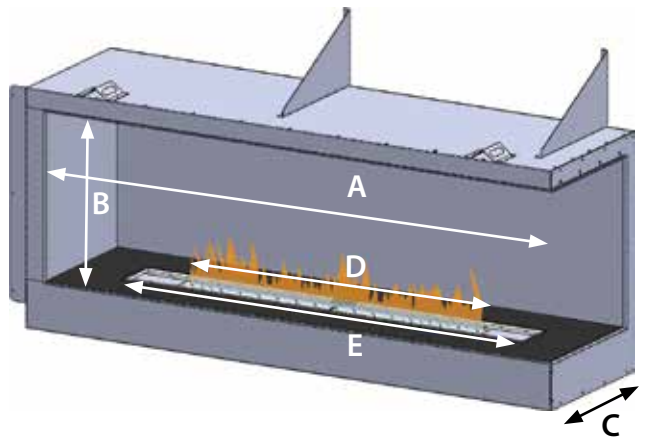

SEE-THROUGH: DIMENSIONS (in.)

	HVF-42-ST	HVF-60-ST	HVF-72-ST
A	42	60	72
B	18	18	18
C	18	18	18
D	37 1/2	37 1/2	37 1/2
E	38	49	59

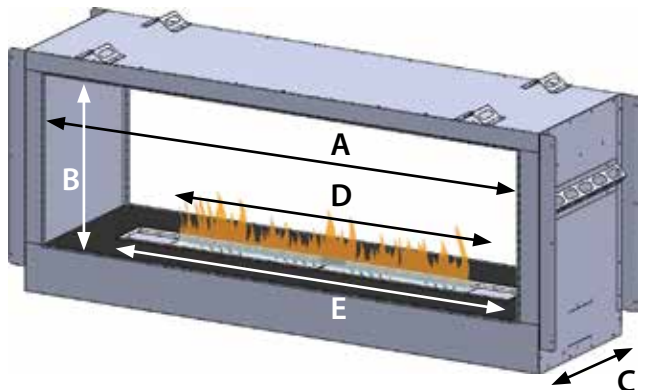

Available in three lengths:
42", 60", and 72"

H SERIES CONFIGURATIONS, Continued



HVF-42 [3-Sided]

The St. Gregory Hotel - Washington, D.C

Installed by Day or Night Home & Hearth Services LLC - Elkridge, MD



HVF-72 [Peninsula]

H Series

3-SIDED: DIMENSIONS (in.)

	HVF-42-3S	HVF-60-3S	HVF-72-3S
A	46 ³ / ₄	59 ⁷ / ₈	71 ⁷ / ₈
B	18	18	18
C	18	18	18
D	37 ¹ / ₂	37 ¹ / ₂	37 ¹ / ₂
E	38	49	59

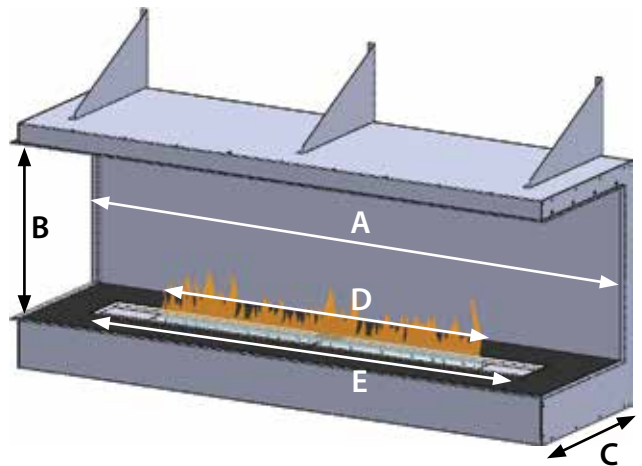

PENINSULA: DIMENSIONS (in.)

	HVF-42-P	HVF-60-P	HVF-72-P
A	44 ¹ / ₂	62 ³ / ₄	74 ¹ / ₂
B	18	18	18
C	18	18	18
D	37 ¹ / ₂	37 ¹ / ₂	37 ¹ / ₂
E	38	49	59

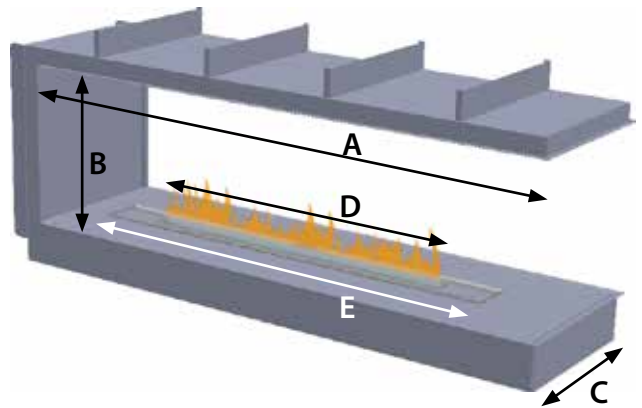

Optional reflective interior enhances the flames



G Series 42" installed by Texas Draft Co., TX

G Series

Looking for a custom design? If you wish to take some extra steps the G Series linear gas burner provides a way to achieve the look of a custom fireplace with the flexibility of an approved dual listed vented and vent-free natural gas burner. This burner can be used in an existing fireplace or in a listed firebox such as Earthcore/Isokern.

The G Series is available in three sizes as a drop in burner (shown above) or with the optional burner cover (shown below). The optional cover is useful for floor level installation because it hides away the controls and burner structure to provide a clean, modern aesthetic. If you are looking for something easier, check out our H Series (pages 10 - 13). They are the same burner as the G Series however they are already integrated with a zero clearance firebox.

G Series 42"
with optional cover



Installed by Embers Fireplaces, NJ

MODEL	G SERIES
-------	----------



Gas Type	Natural Gas (only)
Flame Adjustment	Yes
Vented Available	Yes
Vent-Free Available	Yes
Vented Flue Dimensions	8" Diameter or 50 in. ² Flue Diameter (Vented) N/A (Vent-Free)



Heat Output	25,000 - 37,500 BTU/hr (NG)
Efficiency	85% (Vented) - 99% (Vent-Free)



Thermostatic Remote Control	Yes
Interior Options	N/A
Electronic Ignition	Yes

Certifications	ANSI Z21.11.2 ANSI Z.21.60 CSA 2.26
----------------	-------------------------------------------

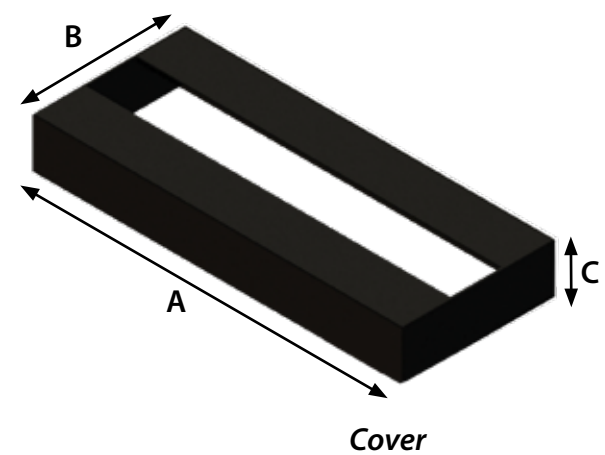

DIMENSIONS (in.)

	GVF-42	GVF-60	GVF-72
A	39 1/8	60	72
B	16 1/4	16 1/4	16 1/4
C	5 5/16	5 5/16	5 5/16
D	38 1/2	38 1/2	38 1/2
E	5 5/16	5 5/16	5 5/16
F	16 1/4	16 1/4	16 1/4
G	39	60	72
H	38 1/2	49 1/4	59 1/4

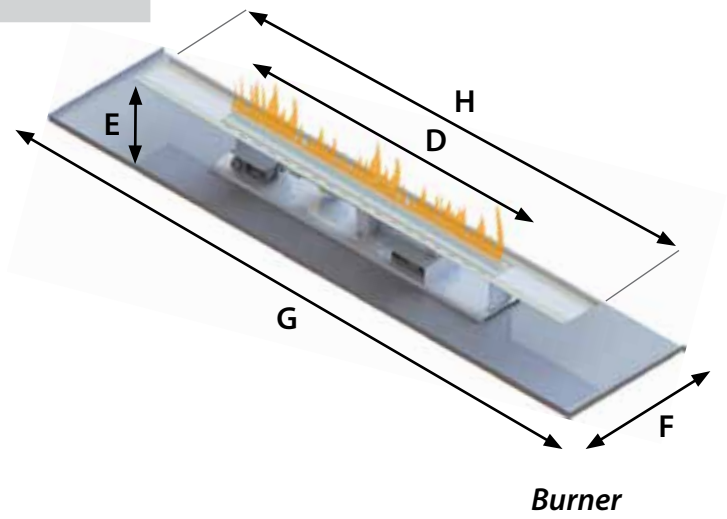

Installed by
Flue tech, Inc., NJ



Gas Stones

For use in a wood burning fireplace or UL listed firebox, our Gas Stones eliminate the “log” look of traditional gas log sets and fireplace inserts. Clean, contemporary and thoroughly modern. If you are looking for a modern alternative to gas logs, this is it. This minimalist design will provide you with a

calming, uncluttered presence in your fireplace for years to come.

Beautiful stones and driftwood crafted from fireproof ceramic sit atop a steel cover fully concealing the gas burner and controls. The burner cover is available in white or black and in two sizes.



24" or 30" Burner Covers available in White or Black

MODEL	GAS STONES
Gas Type	Natural Gas or Propane (Vented) Natural Gas (Vent-Free)
Flame Adjustment	Yes
Vented Available	Yes
Vent-Free Available	Yes
Vented Flue Dimensions	Existing Chimney (Vented) N/A (Vent Free)
Heat Output	27,000 - 42,000 BTU/hr (NG) Vented 27,000 - 43,500 BTU/hr (LP) Vented 27,000 - 39,000 BTU/hr (NG) Vent-Free
Efficiency	32% (NG), 39% (LP) Vented 99% (NG) Vent-Free
Thermostatic Remote Control	No (Vented) Yes (Vent-Free)
Exterior Options	Black or White Steel Cover
Electronic Ignition	Yes
Certifications	ANSI Z21.60b (Vented) CSA 2.26b (Vented) CGA 2.17-M911 (Vented) ANSI Z21.11.2 (Vent-Free)

DIMENSIONS (in.)

	Gas Stones 24 in.	Gas Stones 30 in.
A	24	30
B	6 ¾	6 ¾
C	12	12
D	17 ⅞	17 ⅞
E	5 ⅜	5 ⅜

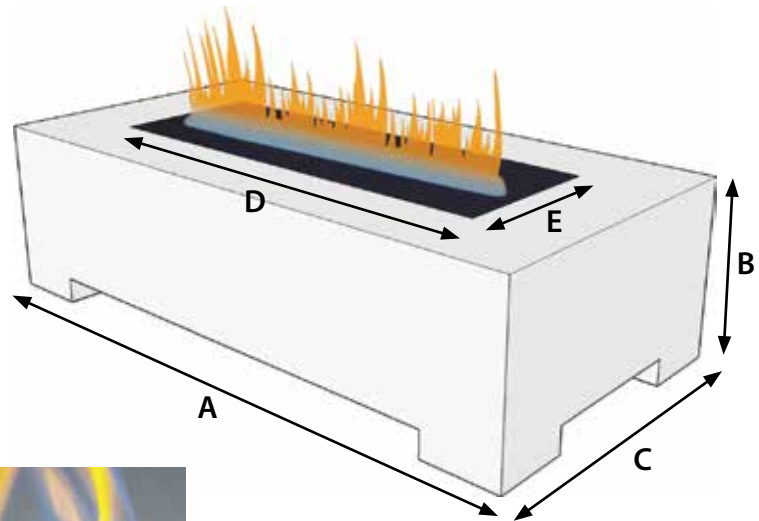

FIRE MEDIA



Beach Stones*



Dover Stones

* Vent-Free models only support Beach Stones fire media.



H Series 3-Sided

*The Residence at W Dallas-Victory in Dallas, TX
Designed by SWOON and Chad Dorsey Design
Built by Gordan Highlander*

About Us

At *European Home*, beautiful design drives everything we do. Founder, Holly Markham, evolved her business into fireplaces by understanding design needs. Because of that dedication we now design, manufacture, and import the highest quality modern fireplaces. From the materials we use, to the efficiency standards we hold, to the skilled hands and innovative minds behind every product – **every detail is considered completely.**

All European Home gas fireplaces are manufactured in the United States and are certified for use in North America.* In addition, European Home is the exclusive importer of the European brands Flamerite Fires and Focus.

**Some restrictions apply for vent-free products. Check your local guidelines.*



H Series
Single-Sided
oldsilvershed.com



H Series
Peninsula
(with optional safety screens)
Installed by
Metro House of Fire, GA



G Series
Custom Burner
Installed by
Embers Fireplaces, NJ



*Installer: Fireside Distributors, FL
Builder: Hedrick Brothers, FL*

H Series Single-Sided

Available Locally Through:

Or Find Your Local Dealer Today:



EuropeanHome
www.europeanhome.com
info@europeanhome.com

