



EuropeanHome

# G S E R I E S

Linear · Hearth · Burner

Product  
Information  
Page



## Installation, Operation and Owner's Manual

GVF-42

GVF-60

GVF-72

**WARNING: If the information in these instructions is not followed exactly, a fire or explosion may result causing property damage, personal injury or loss of life.**

-- Do not store or use gasoline or other flammable vapors and liquids in the vicinity of this or any other appliance.

#### WHAT TO DO IF YOU SMELL GAS

- Do not try to light any appliance.
- Do not touch any electrical switch; do not use any phone in your building.
- Immediately call your gas supplier from a neighbor's phone. Follow the gas supplier's instructions.
- If you cannot reach your gas supplier, call the fire department.

-- Installation and service must be performed by a qualified installer, service agency or the gas supplier.

**This is an unvented gas-fired heater. It uses air (oxygen) from the room in which it is installed. Provisions for adequate combustion and ventilating air must be provided. Refer to page 6.**

**This appliance may be installed in an aftermarket, permanently located, manufactured (mobile) home, where not prohibited by local codes.**

**This appliance is only for use with the type of gas indicated on the rating plate. This appliance is not convertible for use with other gases.**

**INSTALLER: Leave this manual with the appliance.**

**CONSUMER: Retain this manual for future reference.**



OMNI-Test Laboratories, Inc.

Report #284-F-08-4

October 2024

## TABLE OF CONTENTS

Important Safety Information	3
Room Volume for Vent Free	7
Specifications and Dimensions	9
Listing Label	16
Pre-installation Planning	18
Electric Installation	21
Gas Installation	23
Installing the Burner	24
Operating the Burner	26
Maintenance	30
Parts List	31
Warranty	Appendix A
Product Installation Record	Appendix B
Troubleshooting	Appendix C

# IMPORTANT SAFETY INFORMATION

Read these instructions carefully before installing or trying to operate this Vent Free gas heater.

## BEFORE PROCEEDING BEYOND THIS PAGE

**UNDERSTAND THAT THIS BURNER HAS SPECIFIC INSTALLATION INSTRUCTIONS. ANY DEVIATION FROM THESE INSTRUCTIONS WILL VOID WARRANTY AND CAN RESULT IN LOSS OF PROPERTY, INJURY, OR DEATH.**

**WARNING** This appliance is for installation in a solid-fuel burning fireplace or UL 127 factory-built fireplace or in a listed ventless firebox enclosure.

**Exception: DO NOT install this appliance in a factory-built fireplace that includes instructions stating that it has not been tested or should not be used with unvented gas logs.**

**Please review pages 7-9 and 16-23 for further installation requirements.**

# IMPORTANT SAFETY INFORMATION

Read these instructions carefully before installing or trying to operate this Vent Free gas heater.

## WARNING

- **Any change to this heater or its controls can be dangerous.**
- **Improper installation or use of the heater can cause serious injury or death from fire, burns, explosion or carbon monoxide poisoning.**
- **Do not allow fans to blow directly into the fireplace. Avoid any drafts that alter burner flame patterns.**
- **Do not use a blower insert, heat exchanger insert or other accessory, not approved for use with this heater.**

1. Due to high temperatures, the heater should be located out of traffic and away from furniture and draperies.
2. Children and adults should be alerted to the hazard of high surface temperature and should stay away to avoid burns or clothing ignition.
3. Young children should be carefully supervised when they are in the same room with the heater.
4. Do not place clothing or other flammable material on or near the heater.
5. Any safety screen or guard removed for servicing a heater, must be replaced prior to operating the heater.
6. Installation and repair should be done by a qualified service person. Do not modify or substitute any part of this appliance.
7. To prevent malfunction and/or sooting, an unvented gas heater should be cleaned before use and at least annually by a professional service person. More frequent cleaning may be required due to excessive lint from carpeting, bedding material, etc. It is imperative that control compartments, burners and circulating air passageways be kept clean.
8. **CARBON MONOXIDE POISONING:** Early signs of carbon monoxide poisoning are similar to the flu with headaches, dizziness and/or nausea. If you have these signs, obtain fresh air immediately. Have the heater serviced as it may not be operating properly.
9. The installation must conform with local codes or, in the absence of local codes, with the **National Fuel Gas Code, ANSI Z223.1/NFPA54.**
10. This unit complies with ANSI Z21.11.2b-2011 Unvented Heaters and ANSI Z.21.60-2012/CSA 2.26-2012 Decorative Appliances for Installation in Solid-Fuel Burning Fireplaces. Do not install the heater in a bathroom or bedroom.

# IMPORTANT SAFETY INFORMATION

Read these instructions carefully before installing or trying to operate this Vent Free gas heater.

11. Correct installation of the fire media, proper location of the heater, and annual cleaning are necessary to avoid potential problems with sooting. Sooting, resulting from improper installation or operation, can settle on surfaces outside the fireplace. See fire media placement instructions for proper installation.
12. **WARNING:** Avoid any drafts that alter burner flame patterns. Do not allow fans to blow directly into fireplace. Do not place a blower inside burn area of firebox. Ceiling fans may create drafts that alter burner flame patterns. Sooting and improper burning will occur.
13. **Caution:** Candles, incense, oil lamps, etc. produce combustion by-products including soot. Vent free heaters will not filter or clean soot produced by these types of products. In addition, the smoke and/or aromatics (scents) may be reburned in the vent free heater which can produce odors. It is recommended to minimize the use of candles, incense, etc. while the vent free heater is in operation.
14. Keep room area clear and free from combustible materials, gasoline and other flammable vapors and liquids.
15. Unvented gas heaters are a supplemental zone heater. They are not intended to be the primary heating appliance.
16. Unvented gas heaters emit moisture into the living area. In most homes of average construction, this does not pose a problem. In houses of extremely tight construction, additional mechanical ventilation is recommended.
17. During manufacturing, fabricating and shipping, various components of this appliance are treated with certain oils, films or bonding agents. These chemicals are not harmful but may produce annoying smoke and smells as they are burned off during the initial operation of the heater; possibly causing headaches or eye or lung irritation. This is a normal and temporary occurrence. The initial break-in operation should last two to three hours with the burner at the highest setting. Provide maximum ventilation by opening windows or doors to allow odors to dissipate. Any odors remaining after this initial break-in period will be slight and will disappear with continued use.
18. Input ratings are shown in BTU per hour and are for elevations up to 2,000 feet. For elevations above 2,000 feet, input ratings should be reduced 4 percent for each 1,000 feet above sea level. Refer to the National Fuel Gas Code.
19. The heater and its main gas valve must be disconnected from the gas supply piping system during any pressure testing of that system at test pressures in excess of ½ psig (3.5 kPa).

# IMPORTANT SAFETY INFORMATION

Read these instructions carefully before installing or trying to operate this Vent Free gas heater.

20. The appliance must be isolated from the gas supply piping system by closing its equipment shutoff valve during any pressure testing of the gas supply piping system at test pressures equal to or less than ½ psi (3.5 kPa).
21. Do not use this room heater if any part has been under water. Immediately call a qualified service technician to inspect the room heater and to replace any part of the control system and any gas control which has been under water.
22. This heater must not be used with glass doors in the closed position. This can lead to pilot outages and severe sooting outside the fireplace.
23. Never burn solid fuels in a fireplace where an unvented room heater is installed.
24. Always have a fireplace screen in place when the appliance is in operation and, unless other provisions for combustion air are provided, the screen must have an opening(s) for introduction of combustion air.
25. All outside air ducts and/or ash dumps in the fireplace must be permanently closed prior to the installation of the heater.
26. This appliance has been certified by OMNI-Test Laboratories, Inc. to ANSI Z21.11.2b-2011, Unvented Room Heaters and ANSI Z.21.60-2012/CSA 2.26-2012 Decorative Appliances for Installation in Solid-Fuel Burning Fireplaces.
27. This appliance is approved for installation in the Commonwealth of Massachusetts. The Board of State Examiners of Plumbers and Gas Fitters has issued approval number G1-1115-175 for this appliance.

# ROOM VOLUME for VENT FREE

## CODES

Adhere to all local codes or, in their absence, the latest edition of THE NATIONAL FUEL GAS CODE ANSI Z223.1 or NFPA54 which can be obtained from...

American National Standards Institute, Inc.  
1430 Broadway  
New York, NY 10018

or

National Fire Protection Association, Inc.  
Batterymarch Park  
Quincy, MA 02269

## ADEQUATE COMBUSTION AND VENTILATION AIR

This heater shall not be installed in a confined space or unusually tight construction unless provisions are provided for adequate combustion and ventilation air.

The National Fuel Gas Code, (ANSI Z223.1/NFPA 54), defines a *confined* space as a space whose volume is less than 50 cubic feet per 1,000 BTU per hour (4.8 m<sup>3</sup> per kw) of the aggregate input rating of all appliances installed in that space. An *unconfined* space is defined as a space whose volume is not less than 50 cubic feet per 1,000 BTU per hour (4.8 m<sup>3</sup> per kw) of the aggregate input rating of all appliances installed in that space. Rooms communicating directly with the space in which the appliances are installed, through openings not furnished with doors, are considered a part of the unconfined space.

UNUSUALLY TIGHT CONSTRUCTION IS DEFINED AS CONSTRUCTION WHERE...

a) walls and ceilings exposed to the outside atmosphere have a continuous water vapor retarder with a rating of 1 perm (6 x 10<sup>-11</sup> kg per Pa-sec-m<sup>2</sup>) or less with openings gasketed or sealed;

b) weather stripping has been added on operable windows and doors, and

c) caulking or sealants are applied to areas such as joints around window and door frames, between sole plates and floors, between wall-ceiling joints, between wall panels, at penetrations for plumbing, electrical, and gas lines, and at other openings.

**WARNING**

**This appliance is equipped for natural gas. Field conversion is not permitted.**

**WARNING**

**If the area in which the heater may be operated does not meet the required volume for indoor combustion air, combustion and ventilation air shall be provided by one of the methods described in the National Fuel Gas Code, ANSI Z223.1/NFPA 54, the International Fuel Gas Code or applicable local codes.**

# ROOM VOLUME for VENT FREE

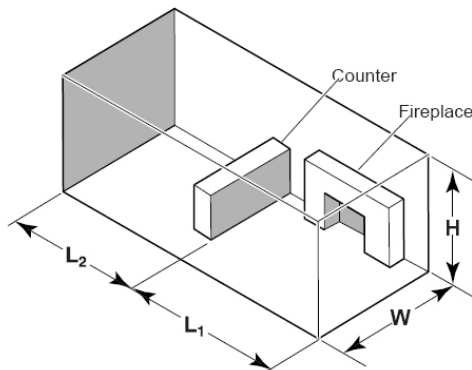

The following formula can be used to determine the maximum heater rating (per the definition of unconfined space) that is allowed in your space:

$$\text{Maximum BTU/Hr.} = \frac{(L1 + L2)\text{ft.} \times (W)\text{ft.} \times (H)\text{ft.}}{50} \times 1000$$

Example A: Consider two connecting rooms with an open area between, with the following dimensions: L1 = 15½ ft., L2 = 12 ft., W = 12 ft., H = 8 ft.

$$\frac{(15\frac{1}{2} + 12)\text{ft.} \times (12)\text{ft.} \times (8)\text{ft.}}{50} \times 1000 = 52,800 \text{ BTU/Hr.}$$

Example B: If there were a door between the two rooms the calculation would be based only on the room with the heater.

$$\frac{(15\frac{1}{2})\text{ft.} \times (12)\text{ft.} \times (8)\text{ft.}}{50} \times 1000 = 29,760 \text{ BTU/Hr.}$$

## Will my space support a G Series Linear Hearth Burner?

Maximum BTU/hr. my space will support (use formula above) a) \_\_\_\_\_

BTU/hr. of European Home G Series Linear Hearth Burner b) 37,500

If the answer to a) is **greater** than b) then your space **will** support the installation of the G Series Linear Hearth Burner; if a) is **less** than b) then your space **will not** support an G Series Linear Hearth Burner.

**WARNING**

**This appliance is for installation in a solid-fuel burning fireplace or UL 127 factory-built fireplace or in a listed ventless firebox enclosure.**

**Exception: DO NOT install this appliance in a factory-built fireplace that includes instructions stating that it has not been tested or should not be used with unvented gas logs.**



# SPECIFICATIONS and DIMENSIONS

## SPECIFICATIONS

<b>G Series Linear Hearth Burner</b> (all sizes)	
Fuel	Natural Gas ONLY
Manifold Pressure	3.5" (0.87 kPa)
Minimum Supply Pressure	4.0" (1.0 kPa)
Maximum Supply Pressure	7.0" (1.7 kPa)
Orifice Size	#47 DMS
Input (High, BTU/hr.)	37,500
Input (Low, BTU/hr.)	25,000
Electrical	6V DC

*Burner Specifications*

The **G Series Linear Hearth Burner** has been certified to two standards:

- ANSI Z21.11.2b-2011, for unvented room heaters
- ANSI Z.21.60-2012/CSA 2.26-2012, for vented decorative appliances

Check the local/state codes to determine if unvented heaters are permitted at your location before installing this product as a vent-free appliance. If unvented heaters are not permitted you may install and operate this product as a vented appliance.

# SPECIFICATIONS and DIMENSIONS

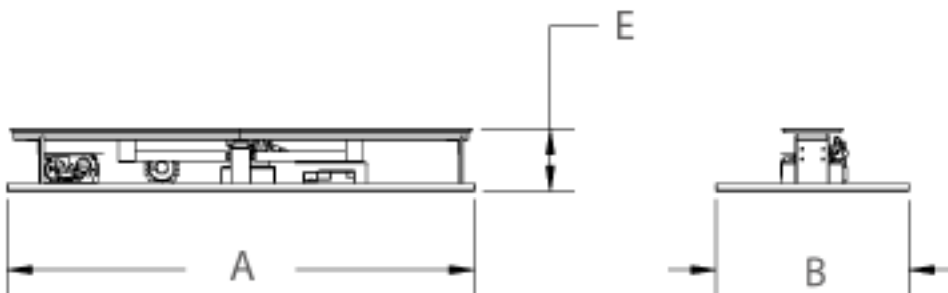
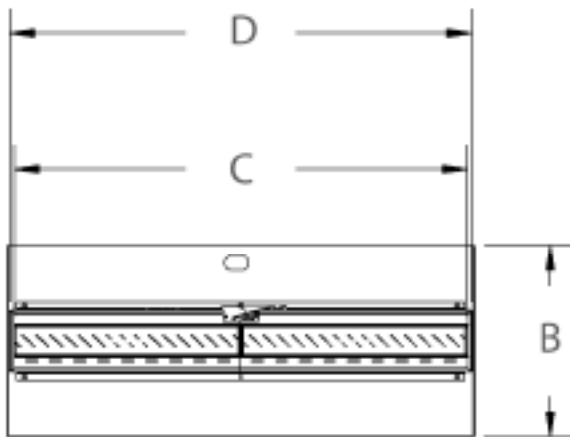
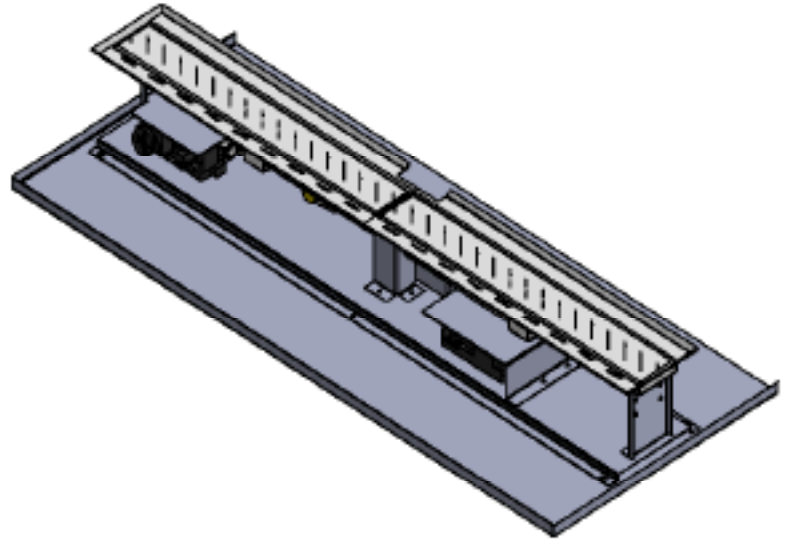

LETTERS	A	B	C	D	E
INCHES	38 3/4"	16 1/2"	37 3/4"	38 3/4"	5 1/2"
[MILLIMETERS]	[988]	[407]	[959]	[984]	[130]

## GVF 42 BURNER

# SPECIFICATIONS and DIMENSIONS

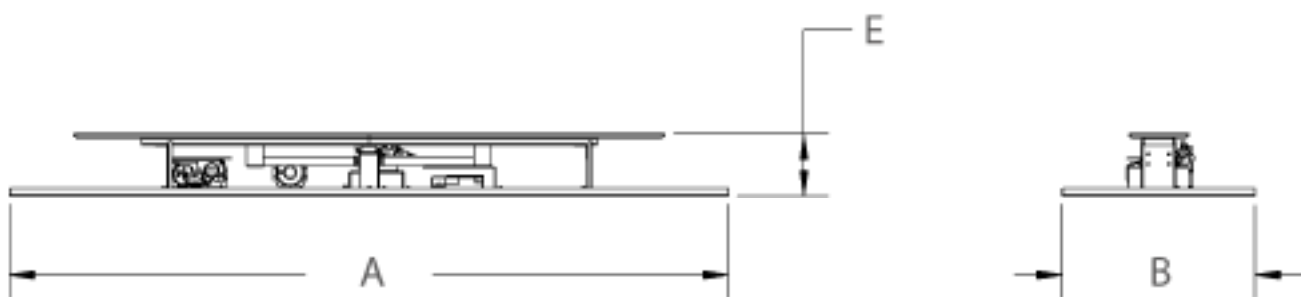
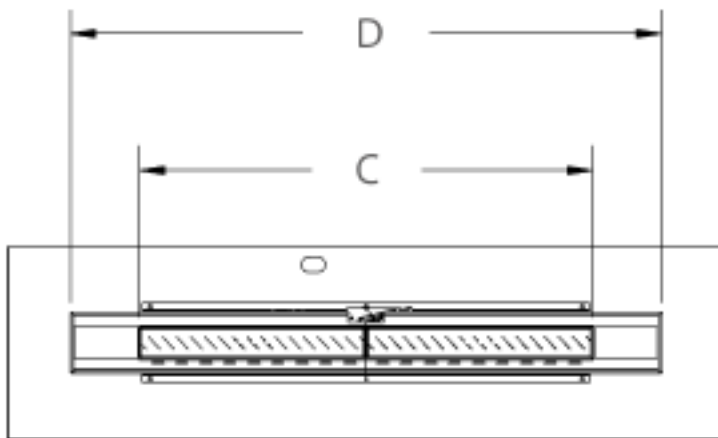
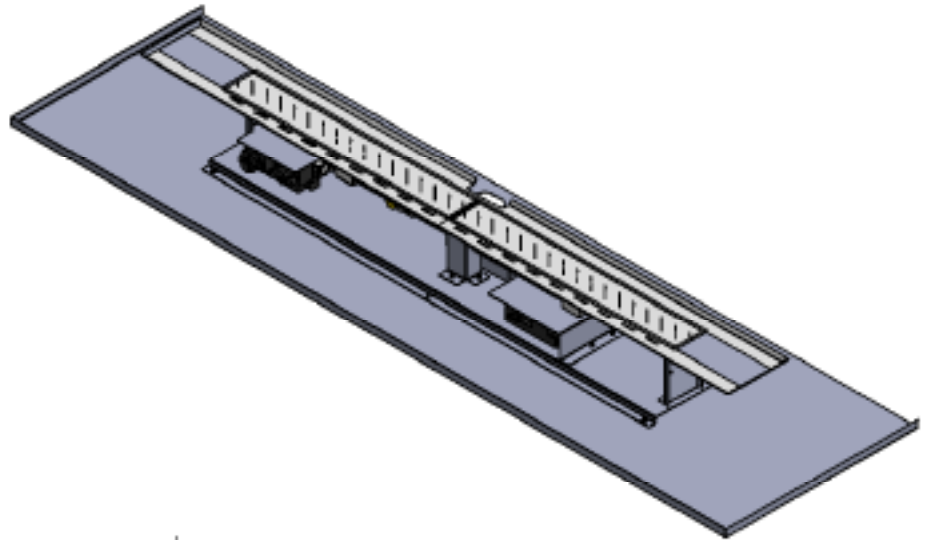

LETTERS	A	B	C	D	E
INCHES	59 3/8"	16 1/2"	37 3/4"	49 3/4"	5 1/4"
[MILLIMETERS]	[1519]	[407]	[959]	[1251]	[130]

## GVF 60 BURNER

# SPECIFICATIONS and DIMENSIONS

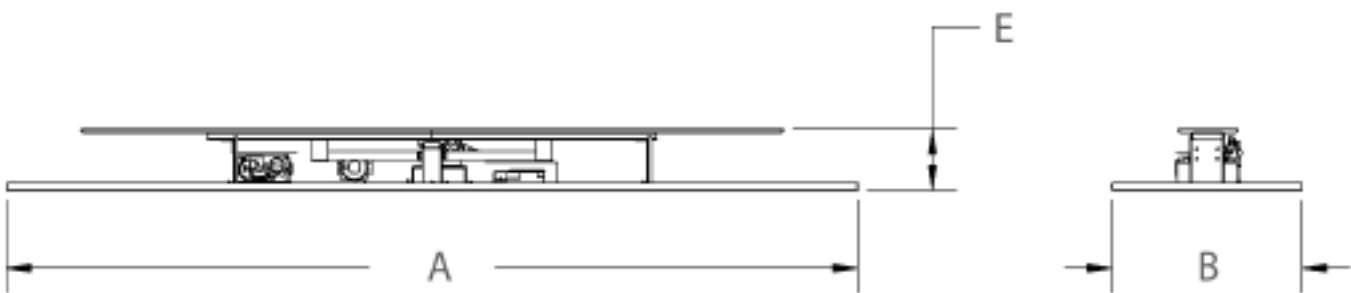
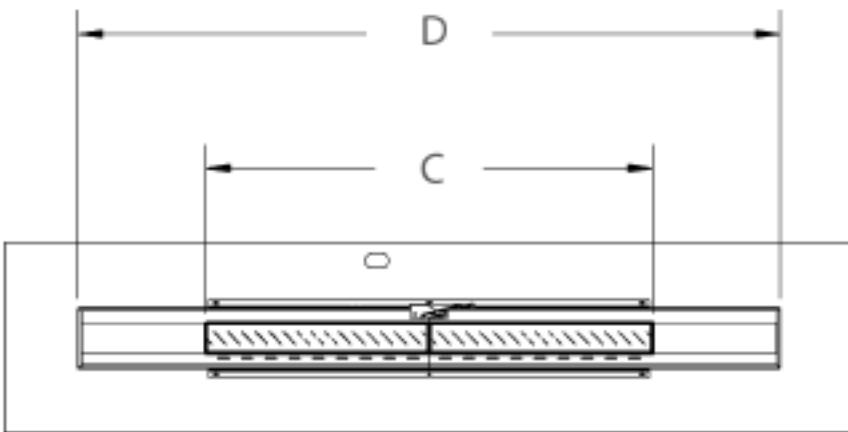
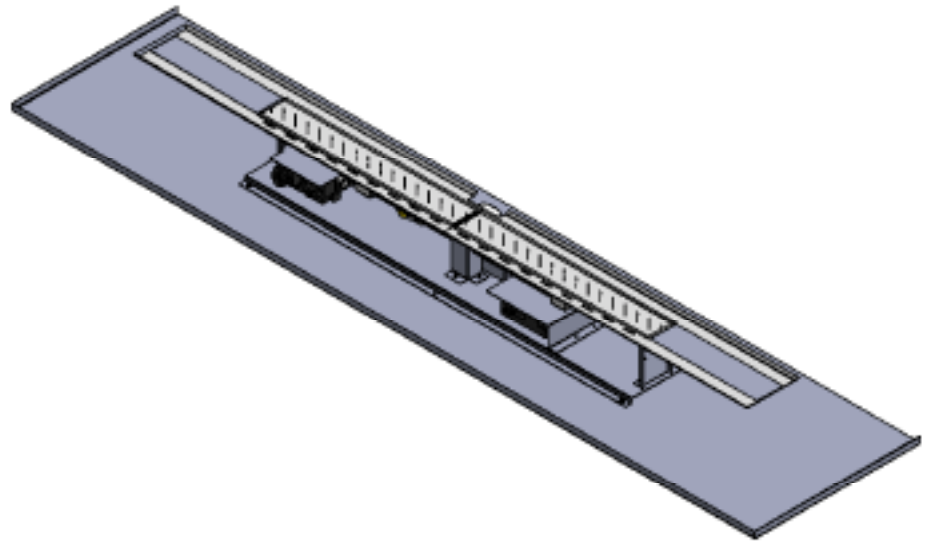

LETTERS	A	B	C	D	E
INCHES	71 3/4"	16 1/2"	37 3/4"	59 1/4"	5 1/2"
[MILLIMETERS]	[1824]	[407]	[959]	[1505]	[130]

## GVF 72 BURNER

# SPECIFICATIONS and DIMENSIONS

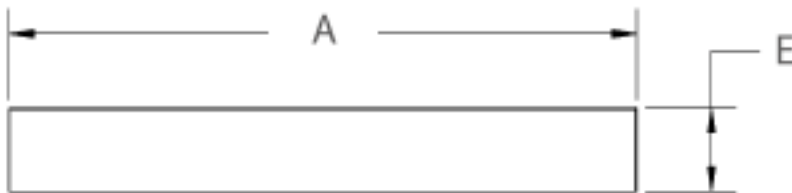
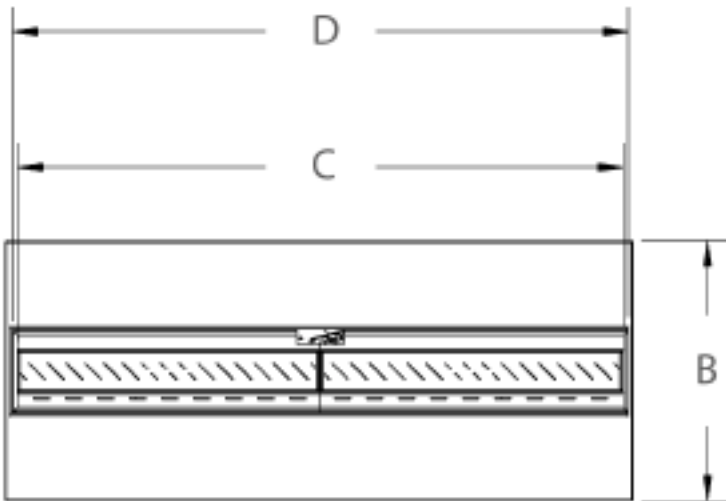
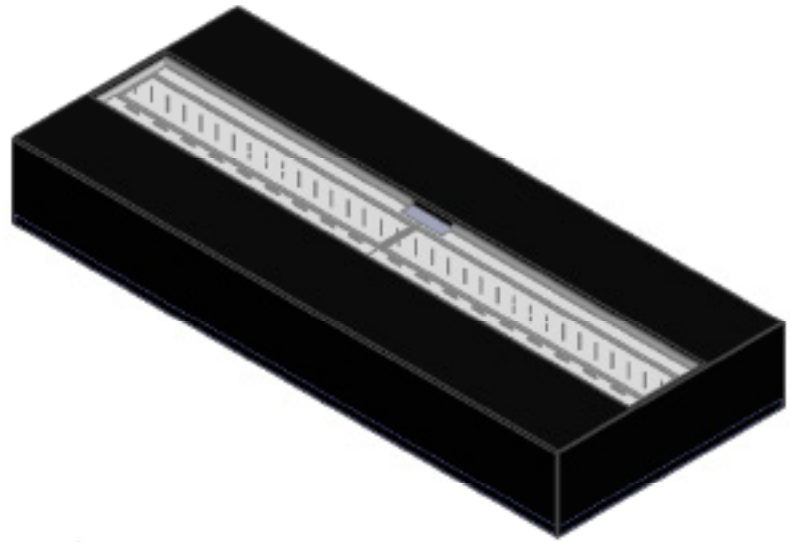

LETTERS	A	B	C	D	E
INCHES	39 1/4"	16 1/4"	37 3/4"	38 3/4"	5 1/4"
[MILLIMETERS]	[994]	[412]	[959]	[975]	[134]

## GVF 42 BURNER COVER

# SPECIFICATIONS and DIMENSIONS

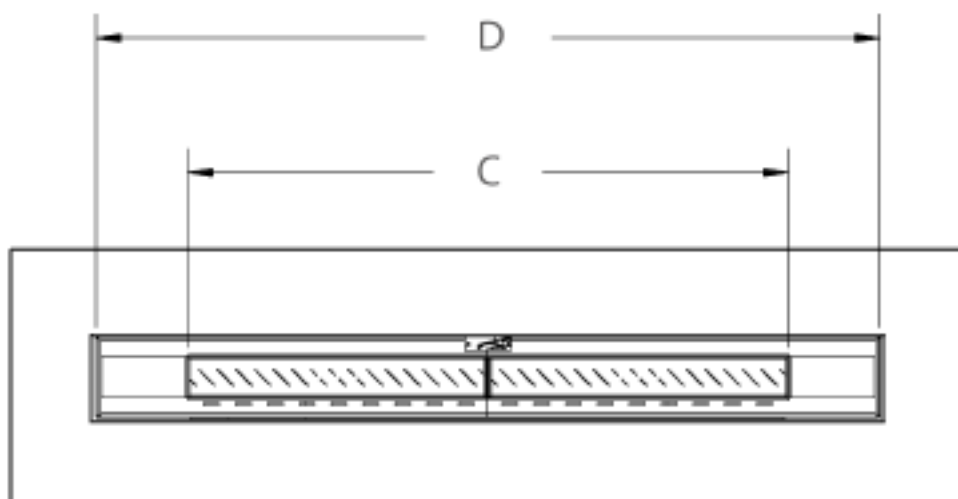

LETTERS	A	B	C	D	E
INCHES	60"	16 1/4"	37 3/4"	49 1/4"	5 1/4"
[MILLIMETERS]	[1524]	[412]	[959]	[1251]	[134]

## GVF 60 BURNER COVER

# SPECIFICATIONS and DIMENSIONS

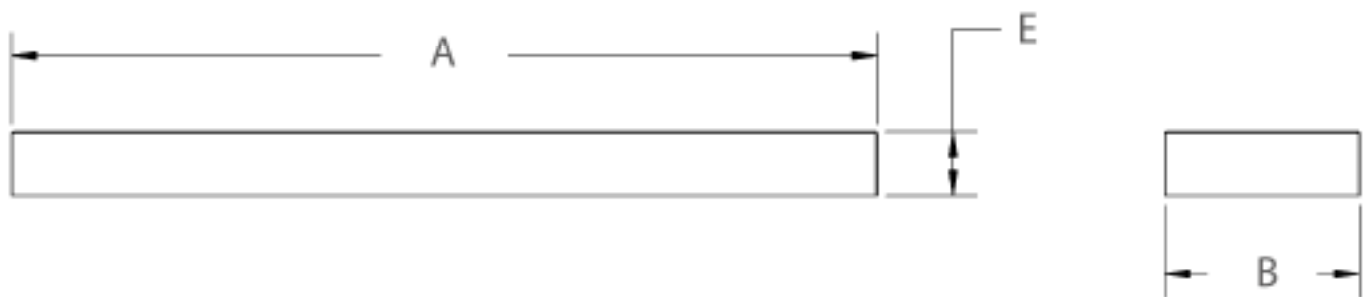
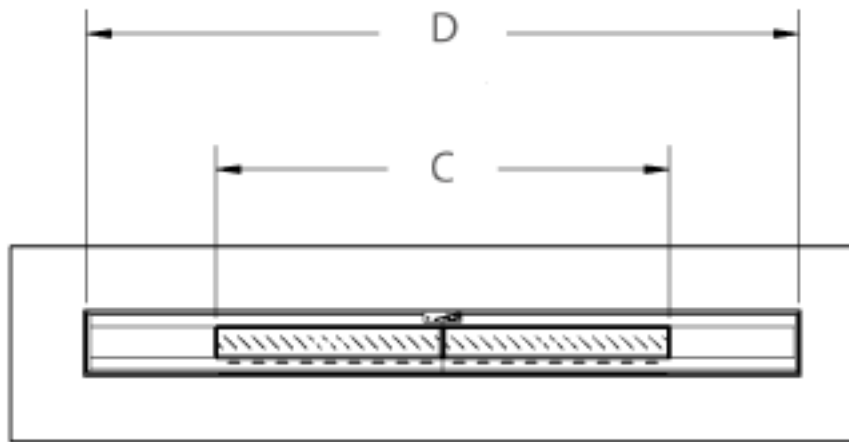

LETTERS	A	B	C	D	E
INCHES	72"	16 1/4"	37 3/4"	59 1/4"	5 1/4"
[MILLIMETERS]	[1829]	[412]	[959]	[1506]	[134]

## GVF 72 BURNER COVER

# SPECIFICATIONS and DIMENSIONS

## CERTIFICATION

OMNI-Test Laboratories, Inc. has certified that the **G Series Linear Hearth Burners** meet the ANSI Z21.11.2b-2011 and ANSI Z.21.60-2012/CSA 2.26-2012 standards.

<b>G Series LINEAR HEARTH BURNER</b>			
Model:	GVF-42 <input type="checkbox"/>	GVF-60 <input type="checkbox"/>	GVF-72 <input type="checkbox"/>
Serial Number: GVF-	_____		
Max. Input BTU/hr.:	37,500	Orifice Size:	#47 DMS
Min. Input BTU/hr.:	25,000	Gas Control:	Maxitrol
Max. Supply Pressure:	7 inches w.c.	Electrical Rating:	6V DC 500mA
Min. Supply Pressure:	4 inches w.c.		
Max. Manifold Pressure:	3.5 inch w.c.		
<b>This appliance is equipped for Natural Gas only.</b>			
<b>MINIMUM SIZE FIREPLACE INTO WHICH THIS APPLIANCE MAY BE INSTALLED</b>			
Opening Height: 18"	Fireplace Depth: 15 3/4"	Flue Area: 50 sq. in.	
Opening Width - GVF-42:	39 1/2" without cover, 44 1/8" with cover		
Opening Width - GVF-60:	50" without cover, 65" with cover		
Opening Width - GVF-72:	60" without cover, 77" with cover		
Mantel to fireplace opening:	11.0"		
Maximum horizontal mantel extension:	12.0"		
<p>This product has been certified by OMNI-Test Laboratories to ANSI Z21.11.2b-2011 <i>Unvented Heaters</i> and ANSI Z.21.60-2012/CSA 2.26-2012 <i>Decorative Appliances for Installation in Solid-Fuel Burning Fireplaces</i>. This appliance must be installed in accordance with local codes, if any; if none, follow the ANSI Z223.1. Installation and service must be performed by a qualified installer, service agency or the gas supplier.</p> <p>This appliance shall not be field converted.</p> <p>WARNING: Do not use a blower insert, heat exchanger insert or other accessory not approved for use with this heater.</p> <p>WARNING: Improper installation, adjustment, alteration, service or maintenance can cause property damage, personal injury or loss of life. Refer to the owner's information manual provided with this appliance. Installation and service must be performed by a qualified installer, service agency or the gas supplier.</p> <p>This heater shall not be installed in a bedroom or bathroom.</p> <p>This appliance is intended for supplemental heating.</p> <p>Failure to use only parts specifically approved with this heater may result in property damage or personal injury. See instruction manual for further information.</p> <p>Apply loose material per instruction manual. DO NOT apply extra material or material not supplied with the heater. Replace only with European Home Fire Media approved for G Series Linear Hearth Burners.</p> <p>WARNING: All previously applied loose material must be removed prior to reapplication.</p>			
<p><b>CAUTION:</b> Hot while in operation. Do not touch. Severe burns may result. Keep children, clothing, furniture, gasoline and other liquids having flammable vapors away.</p> <p><b>WARNING:</b> When used without adequate combustion and ventilation air, heater may give off excessive <b>CARBON MONOXIDE</b>, an odorless, poisonous gas.</p> <div style="border: 1px solid black; padding: 5px; margin-bottom: 5px;"> <p><b>DO NOT INSTALL HEATER UNTIL ALL NECESSARY PROVISIONS ARE MADE FOR COMBUSTION AND VENTILATION AIR. CONSULT THE WRITTEN INSTRUCTIONS PROVIDED WITH THE HEATER FOR INFORMATION CONCERNING COMBUSTION AND VENTILATION AIR. IN THE ABSENCE OF INSTRUCTIONS, REFER TO THE NATIONAL FUEL GAS CODE, ANSI Z223.1/NFPA 54, AIR FOR COMBUSTION AND VENTILATION, OR APPLICABLE LOCAL CODES.</b></p> </div> <p>This heater is equipped with a <b>PILOT LIGHT SAFETY SYSTEM</b> designed to turn off the heater if not enough fresh air is available.</p> <div style="border: 1px solid black; padding: 5px; margin-bottom: 5px;"> <p><b>DO NOT TAMPER WITH THE PILOT LIGHT SAFETY SYSTEM!</b></p> </div> <p>If heater shuts off, do not relight until you provide fresh air. If heater keeps shutting off, have it serviced. Keep burner and control compartment clean.</p> <div style="border: 1px solid black; padding: 5px; margin-bottom: 5px;"> <p><b>CARBON MONOXIDE POISONING MAY LEAD TO DEATH.</b></p> </div> <p>Early signs of carbon monoxide poisoning resemble the flu, with headache, dizziness and/or nausea. If you have these signs, heater may not be working properly. <u>Get fresh air at once! Have heater serviced.</u></p> <p>Some people – pregnant women, persons with heart or lung disease, anemia, those under the influence of alcohol, those at high altitudes – are more affected by carbon monoxide than others.</p> <div style="border: 1px solid black; padding: 5px; margin-bottom: 5px; text-align: center;"> <p>FOR YOUR SAFETY</p> <p>Do not store or use gasoline or other flammable vapors and liquids in the vicinity of this or any other appliance.</p> </div> <p><b>Removal of this marking will void compliance of this heater with ANSI Z21.11.2.</b></p>			
		<p>manufactured by: <b>EUROPEAN HOME</b> 376 Washington Street Malden, MA 02148 tel: (781) 324-8383 www.europeanhome.com</p>	
		GVFLL130827	

### G Series Linear Hearth Burner Listing Label

<b>MINIMUM SIZE FIREPLACE INTO WHICH THIS APPLIANCE MAY BE INSTALLED</b>			
Opening Height:	18" (457 mm)	Fireplace Depth: 15 3/4" (400 mm)	Flue Area 50 Sq. Inches (1270 Sq. mm)
Opening Width	GVF-42:	39 1/2" (1003 mm) without Cover	44 1/8" (1121 mm) with Cover
Opening Width	GVF-60:	50" (1270 mm) without Cover	65" (1651 mm) with Cover
Opening Width	GVF-72	60" (1524 mm) without Cover	77" (1956 mm) with Cover



# SPECIFICATIONS and DIMENSIONS

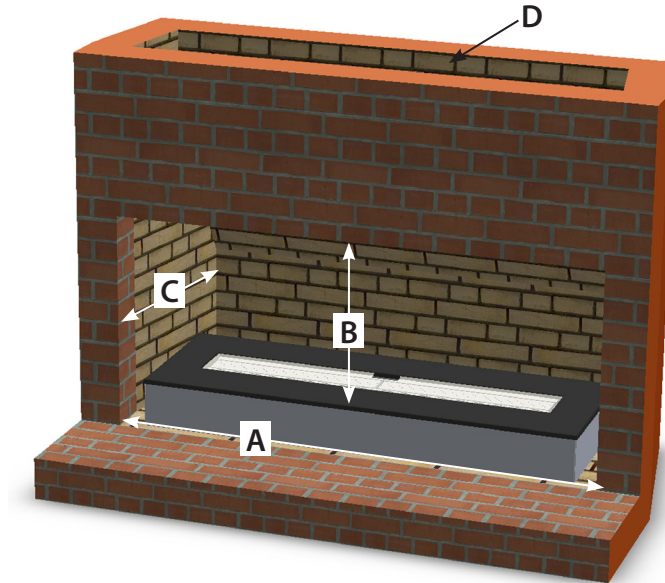

	GVF-42	GVF-60	GVF-72
A (Opening Width without Cover)	39½"	50"	60"
A (Opening Width with Cover)	44⅛"	65"	77"
B (Distance to Lintel)	18"	18"	18"
C (Fireplace Depth)	15¾"	15¾"	15¾"
D (Flue Opening)	50 sq. in.	50 sq. in.	50 sq. in.

*Minimum Fireplace Dimensions Required by Model*

## HIGH ALTITUDE INSTALLATIONS

These appliances are tested and approved without requiring changes when installed at elevations from 0 to 2,000 feet.

When installing these fireplaces at altitudes above 2,000 feet reduce the input rate by 4% for each 1,000 above 2,000 feet. Consult with your local gas supplier to determine the proper orifice size.

# PRE-INSTALLATION PLANNING

## BEFORE YOU BEGIN

Thank you for purchasing an **G Series Linear Hearth Burner** by **European Home**. This product has been designed to provide you with safe, trouble-free operation.

Please read this manual thoroughly before beginning the installation. It has information which is important for safe installation and operation.

Please inspect your shipment for completeness and any damage. Contact your retailer if any damage is found. Do not install your appliance with any damaged or substituted parts.

The installation of your **G Series Linear Hearth Burner** will follow the steps listed:

- **Pre-Installation Planning**
- **Electric Installation**
- **Gas Installation**
- **Installing the Burner**

Before you begin the installation you should have the following tools and supplies:

- Pipe wrenches
- Safety glasses and gloves
- Approved pipe joint sealant
- Manometer
- Leak detection fluid (non-corrosive) or electronic gas detector
- Appropriate gas supply line parts

# PRE-INSTALLATION PLANNING

## APPROVED INSTALLATIONS

Your **G Series Linear Hearth Burner** is to be installed in a solid-fuel burning fireplace or a prefabricated fireplace listed to UL-127 or in a listed ventless firebox enclosure.

When installed your linear hearth burner must sit fully inside the fireplace, behind the fireplace lintel.

**WARNING:** Before installing in a solid-fuel burning fireplace, the chimney flue and firebox must be cleaned of soot, creosote, ashes and loose paint by a qualified chimney cleaner.

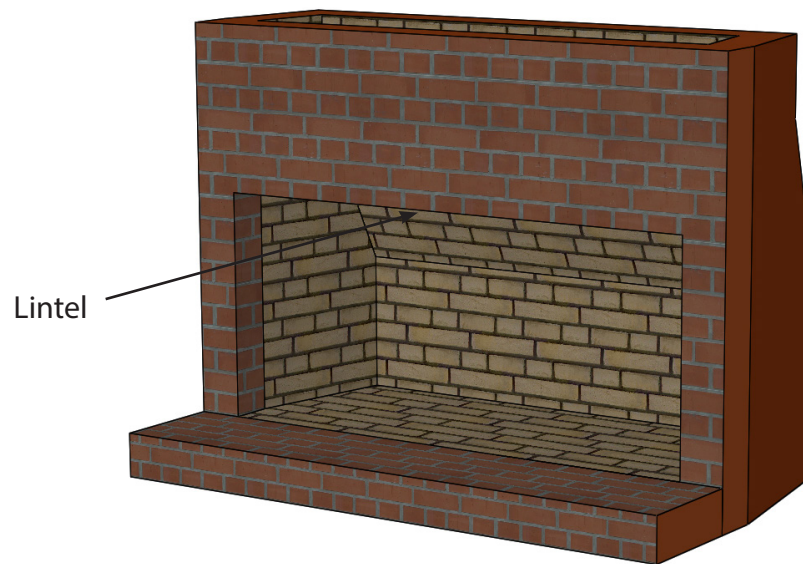

# PRE-INSTALLATION PLANNING

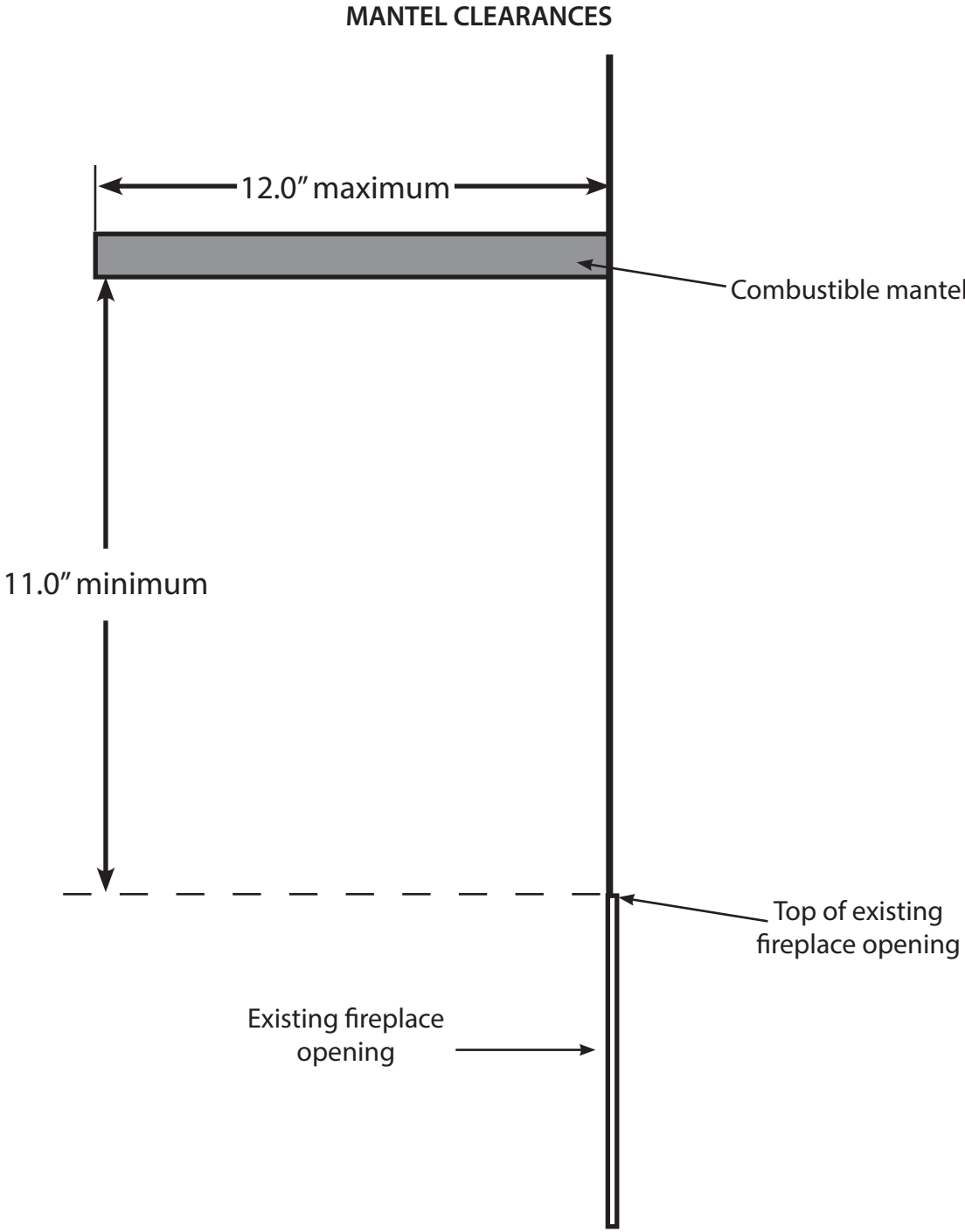

Combustible mantels may be no closer to the fireplace opening than 11.0" or deeper than 12.0".

# ELECTRIC INSTALLATION



## WARNING

*When servicing controls label all wires prior to disconnection. Wiring errors can cause improper and dangerous operation.*

*This appliance must be electrically grounded in accordance with local codes, or, in the absence of local codes, with either the National Electrical Code ANSI/NFPA 70.*

*Electrical work should only be performed by a qualified, licensed electrician. Electric power must be off when making connections at the junction box or performing any service.*

*All wiring shall be in compliance with all local, city, and state codes.*

## ELECTRICAL REQUIREMENTS

The **G Series Linear Hearth Burner** uses a receiver and remote control for its burner operation. The remote control is powered by a 9V battery and the receiver is powered by an 120V AC wall adapter.

**This installation must provide for an approved 120V AC wall receptacle to be placed within the six foot cord limit of the wall adapter.**

**DO NOT place batteries in the receiver when powering the receiver via the wall adapter.**

**All installations must be in compliance with any and all applicable electrical codes.**



AC Adapter



AC Adapter Connected to Receiver

# ELECTRIC INSTALLATION

## G SERIES BURNER ELECTRICAL SCHEMATIC

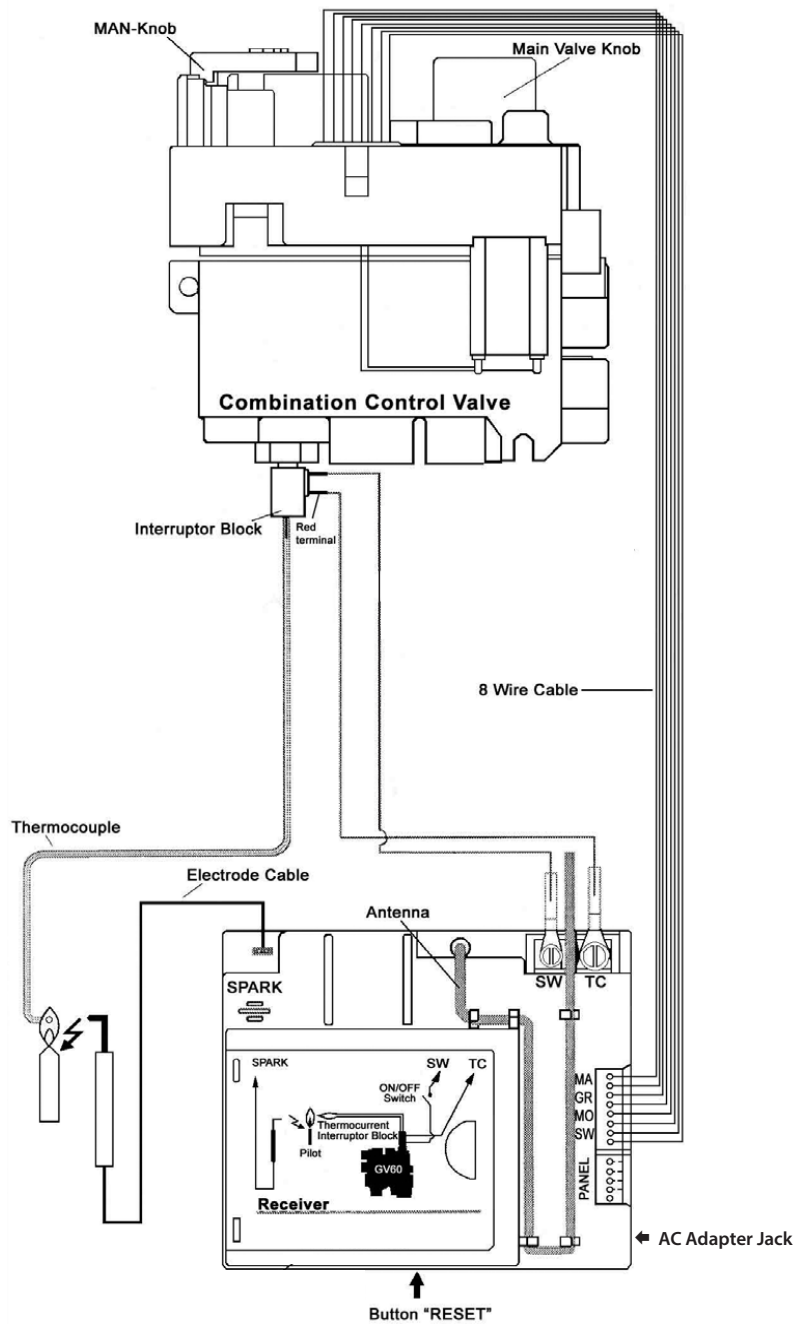

# GAS INSTALLATION

## Note

The installation of this product must conform with local codes or, in the absence of local codes, with the *National Fuel Gas Code, ANSI Z223.1*

This product is shipped from the factory for use with natural gas *ONLY*. Conversion to another fuel is *NOT* permitted.

This product must be installed by a licensed plumber or gasfitter when installed within the Commonwealth of Massachusetts.

## INSTALL THE GAS SUPPLY

The table below shows the dimensions, for all models, of the area to the *rear* of the burner module which is concealed by the optional burner cover. Route the gas supply so that it terminates inside this area (shown below.) The gas supply piping should have a separate gas shutoff valve and a capped,  $\frac{1}{8}$ " pipe tapping upstream of the valve for the purpose of reading pressure. The gas supply line must terminate with a  $\frac{3}{8}$ " male flare fitting.

The Hearth Burner must be isolated from the gas supply system by closing the service valve during any pressure testing of the gas supply system at test pressures equal to or less than  $\frac{1}{2}$  psi (3.5 kPa).

Verify the gas pressure using the upstream  $\frac{1}{8}$ " pipe tap.

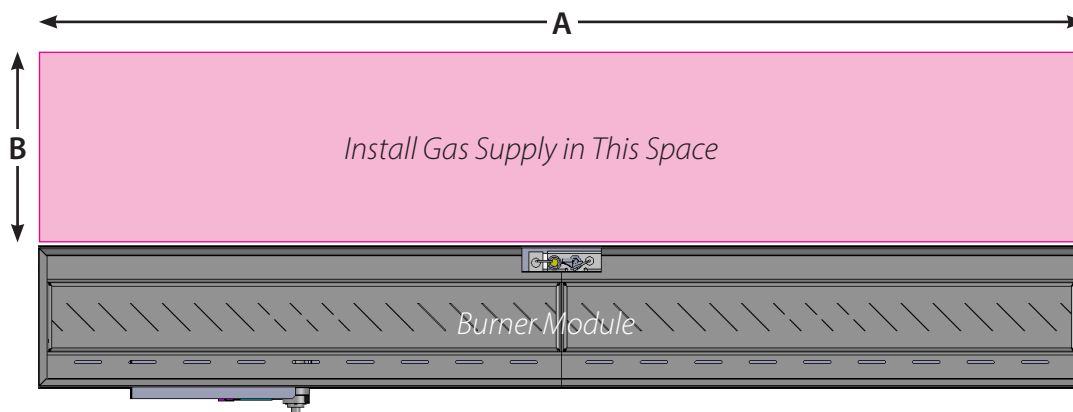

Top View of Burner Module Showing Area for Gas Supply

	All Models
A	39"
B	7"

Area for Gas Supply (hidden by cover)

# INSTALLING the BURNER

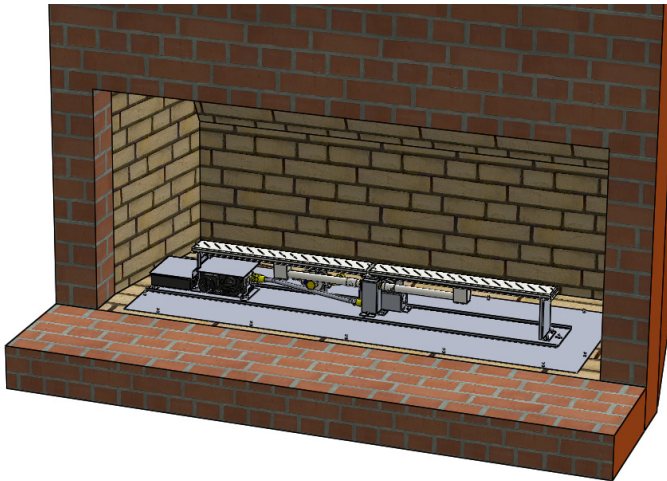

Place the burner in the center of the fireplace and connect the gas supply to the flexible connector attached to the burner.

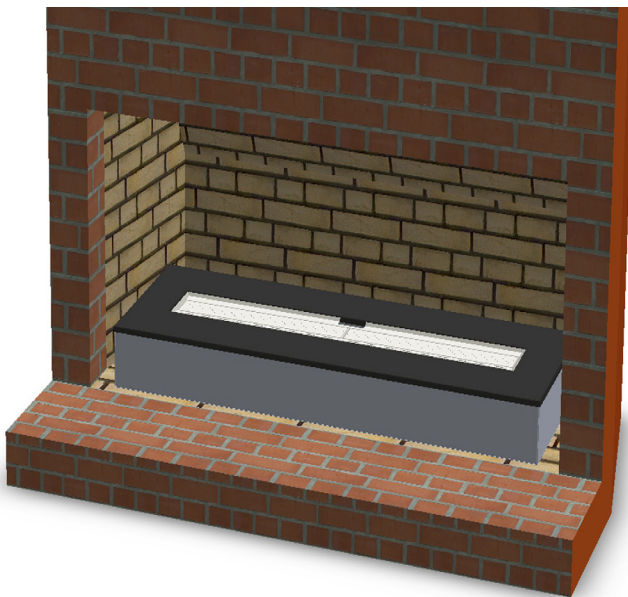

After the gas supply has been connected, open the main supply and check all of the fittings for gas leaks. **Never use a flame to test for leaks.**

Place the optional cover over the burner so the burner is centered in the cover opening as shown at left

**WARNING:** Failure to position the parts in accordance with these diagrams or failure to use only parts specifically approved with this product may result in property damage or personal injury.



# INSTALLING the BURNER

## INSTALLING THE FIRE MEDIA

Your **G Series Linear Hearth Burner** comes with two types of fire media; crushed glass or Carrara pebbles.

### The Fire Media

The contents of the bag of burner media should be spread to an even depth across the entire burner top. The pilot flame should be clear of the fire media by  $\frac{1}{4}$ "

## BEFORE THE FIRST FIRE

1. Make sure all flammable materials have been removed from inside and around the fireplace.
2. Confirm that the wiring is secure.
3. Check the gas supply for leaks.
4. Confirm the proper placement of the burner media.

# OPERATING the BURNER

## RESETTING THE SYSTEM (Pairing the Remote and Receiver)

The **G Series Linear Hearth Burner** should need to be reset only once, prior to initial use. This is done as follows:

1. Press and hold the receiver reset button (shown below) until you hear the second of two beeps.
2. After the second beep release the reset button and, within twenty seconds, press the **SMALL FLAME** button on the remote until you hear the second of two beeps.



## THE FIRST FIRE

The first time you light your **G Series Linear Hearth Burner** an odor may be given off by the unit. This is normal and is a result of the 'burn off' of the lubricants and sealants used when manufacturing the appliance. We recommend that you open the nearby windows for extra ventilation and operate the appliance for at least an hour.

During this first fire, examine the flame for appearance and quality. Examine the burner media for sooting. The flames should mostly yellow with blue bases. The flames should not have dark tips.

# OPERATING the BURNER

## FOR YOUR SAFETY READ BEFORE LIGHTING

**WARNING:** If you do not follow these instructions exactly, a fire or explosion may result causing property damage, personal injury or loss of life.

A. This appliance is equipped with an ignition device which automatically lights the pilot. Do not try to light the pilot by hand.

B. BEFORE LIGHTING, smell all around the heater area for gas. Be sure to smell next to the floor because some gas is heavier than air and will settle on the floor.

### WHAT TO DO IF YOU SMELL GAS

- Do not try to light any appliance.
- Do not touch any electric switch; do not use any phone in your building.
- Immediately call your gas supplier from a neighbor's phone. Follow the gas supplier's instructions.
- If you cannot reach your gas supplier, call the fire department.

C. Do not use this appliance if any part has been under water. Immediately call a qualified service technician to inspect the appliance and to replace any part of the control system and any gas control which has been under water.

### LIGHTING THE FIRE

1. STOP! Read the safety information above.
2. This appliance is equipped with an ignition device which automatically lights the pilot. Do not try to light the pilot by hand.
3. Push the **OFF** button on the remote control to ensure the appliance is off.
4. Wait five (5) minutes to clear out any gas. Then smell for gas including near the floor. If you smell gas, STOP! Follow "B" in the safety information above. If you don't smell gas, go to the next step.
5. Press the **OFF** and **LARGE FLAME** buttons simultaneously. Release the buttons once you hear a beeping noise. This acoustic signal tells you that the start sequence has begun. Further short signals will continue for 8-10 seconds until main gas flows and the burner is lit. If the pilot or burner does not light, go back to Step 3, above.
6. Use the **LARGE FLAME** and **SMALL FLAME** buttons to adjust the flame height.



*G Series Remote Control*

### TO TURN OFF THE APPLIANCE

7. Push the **OFF** button on the remote control to turn the appliance off.

# OPERATING the BURNER

## USING THE REMOTE CONTROL ELECTRONIC IGNITION SYSTEM

### Setting °C/24 Hour or °F/12 Hour Clock.

Press **OFF** and **SMALL FLAME** to toggle between °F/12 hr and °C/24 hr clock.

### Setting the Time.

Simultaneously press the **SMALL FLAME** and **LARGE FLAME** buttons, the display now flashes.

Press **LARGE FLAME** to set the hour and **SMALL FLAME** to set the minute.

Press **OFF** to return to manual mode.

### Changing the Mode of Operation.

Briefly pressing the **SET** button changes the mode of operation in the following order:

**Man** - **☀Temp** - **⌋Temp** - **Timer** - back to **Man**

### ☀Man - Manual Flame Height Adjustment.

You are now able to use the remote control. To increase the flame, the **LARGE FLAME** button should be depressed. Pressing the **SMALL FLAME** button on the handset will reduce the flame. The main flame may be lowered all the way down until it is off, leaving only the pilot ignited.

### Fully Extinguishing the Appliance.

From any heat setting, press the **OFF** button for a few seconds. This will cause the burner to fully extinguish. The system has a safety interlock which will not allow the ignition until the interlock rests. This may take a few minutes.

The appliance should be shut off completely using the **OFF** button on the handset and not left on pilot only, except for temporary use. This resets the system and all safety features.

### ☀Temp - Daytime Temperature Mode.

The appliance must be in standby mode; pilot ignited. The room temperature is measured and compared to the set temperature. The flame height is then automatically adjusted (up or down) to reach the daytime set temperature.

### ⌋Temp - Nighttime Setback Temperature Mode.

The appliance must be in standby mode; pilot ignited. The room temperature is measured and compared to the nighttime setback temperature. The flame height is then automatically adjusted (up or down) to achieve the nighttime setback temperature.

### Timer Mode.

The appliance must be in standby mode; pilot ignited. The Timer setting allows you to set two burner **☀Temp** times and two burner **⌋Temp** times every 24 hrs.

For **⌋Temp** to operate as a thermostat, **TEMP** must be set at 4°C/40°F or higher.

If the **⌋Temp** setting is decreased to - -, the motor will turn the valve to the standby position in the **⌋** times and await the next burner **☀Temp** cycle.

# OPERATING the BURNER

## Setting the Temperature.

Select either the **Temp** mode or the **Temp** mode by briefly pressing the **SET** button.

Hold the **SET** button until the TEMP display flashes.

Set the desired temperature with **SMALL FLAME** or **LARGE FLAME**.

Press **OFF** to complete the program.

## Setting the Timer.

Select Timer mode by briefly pressing the **SET** button.

Press and hold the **SET** button until the P1 is displayed, and the time flashes. Set the hour by pressing **LARGE FLAME** and set the minutes by pressing **SMALL FLAME**.

Briefly press **SET** button for the next burner cycle time.

Once all four times are set, press **OFF** to complete the programming.

### **Automatic Turndown**

1. In Manual/Temperature/Timer modes, the valve will turn to pilot flame if there is no change in flame height for a six hour period. In Temperature or Timer mode, if the ambient room temperature changes, the flame height will adjust automatically to maintain set temperature and the fire will continue to function normally. The valve will turn to pilot flame if the set temperature and the ambient room temperature remain the same over a six hour period.

2. The valve turns to pilot flame if the temperature in the receiver is higher than 140°F/60°C. The main burner comes back on only when the temperature is below 140°F/60°C.

### **Automatic Shut Off**

1. With low battery power in the receiver, the system shuts off the fire completely. This does not happen if the power supply is interrupted.

2. The system shuts off the fire completely if there is no change in flame height for 5 days.

3. The system shuts off the fire if the main burner does not completely ignite approximately 20 seconds after ignition or after pushing the **MAN** button.



Gas Control Valve

# MAINTENANCE

A qualified service agency should conduct an annual inspection and maintenance of your **G Series Linear Hearth Burner** to keep it running safely. The following procedures should be performed only by a qualified service person. The gas supply should be turned off whenever a maintenance procedure is performed. All parts of the fireplace that are removed for servicing must be replaced prior to operation.

## **Cleaning the Media and Burner.**

With all parts of the fireplace at room temperature, carefully remove and clean the fire media with a soft bristled brush.

Clean the burner surface with a brush and clean the rest of the burner module, including the pilot burner, with a vacuum cleaner. After lifting off the cover, ensure that the Primary Air Openings (shown below, at the end of each Burner Inlet Tube) remains free of dust or debris. These openings may be cleaned with a vacuum cleaner or brush.

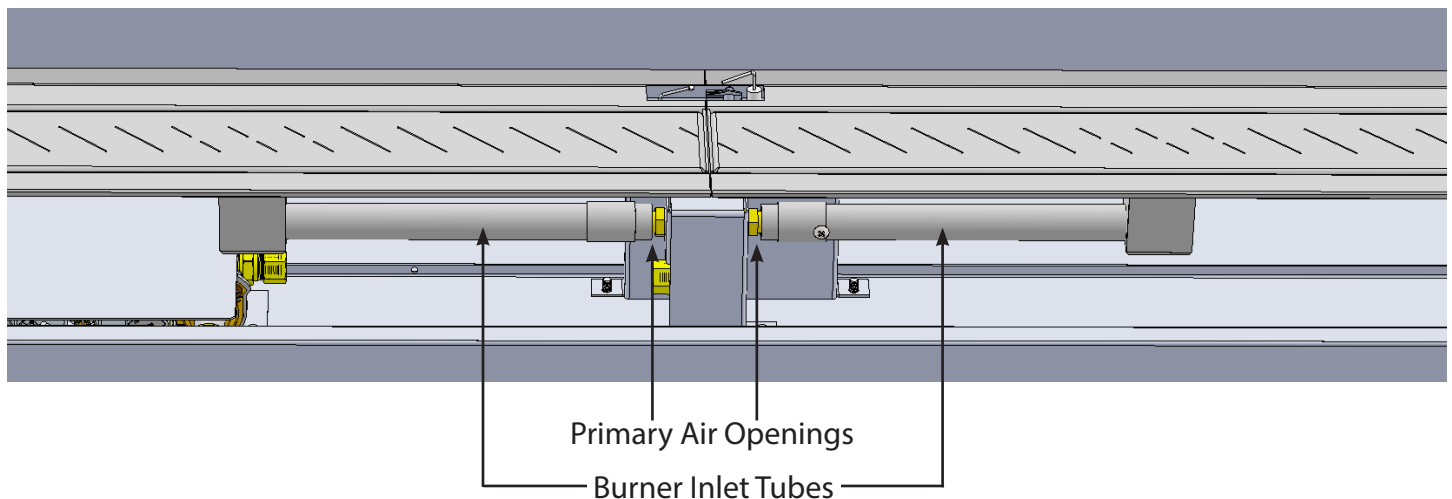

**WARNING** Failure to keep the primary air opening of the burner clean may result in sooting and property damage.

# MAINTENANCE

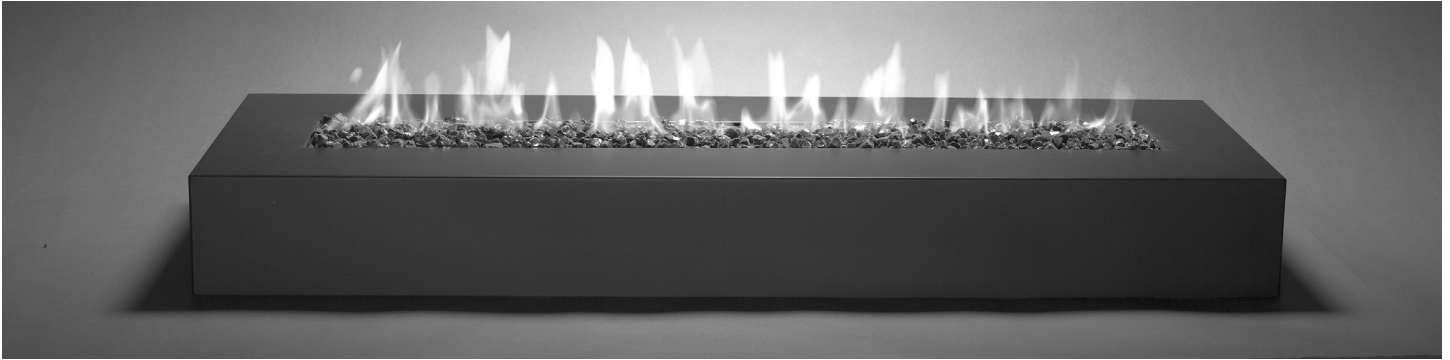

Make a periodic visual inspection of the pilot and main burner flames. The burner flames should look similar to those shown above.

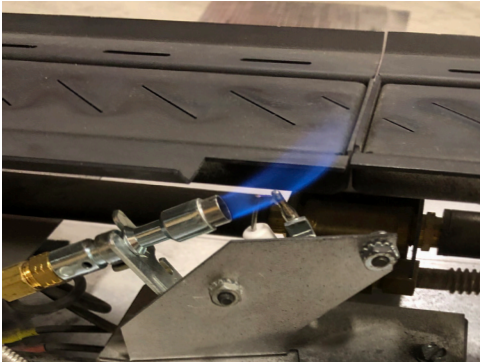

The pilot flame should look similar to that shown at left.

## G SERIES LINEAR HEARTH BURNER PARTS LIST

GS-G6R-R3AM  
GS-G6R-H3T5  
V-VF-GS-PA-01

Receiver  
Remote Control  
Pilot Burner Assembly

For replacement parts and customer service:

**Contact your local Dealer**

# APPENDIX A

## European Home Warranty for The G Series Linear Hearth Burners

European Home warrants the gas controls and burner of the G Series Linear Hearth Burner against defects in materials and workmanship for a period of TWO (2) YEARS from the date of original retail purchase. We warrant the G Series cover against defects in materials and workmanship for a period of FIVE (5) YEARS from the date of original retail purchase. If a defect exists, at its option, European Home will (1) provide needed components to repair the product at no charge, using new or refurbished replacement parts or (2) exchange the product with a product that is new or which has been manufactured from new or serviceable used parts and is at least functionally equivalent to the original product. A replacement product/part assumes the remaining warranty of the original product or ninety (90) days from the date of replacement or repair, whichever provides longer coverage for you. When a product or part is exchanged, any replacement item becomes your property and the replaced item becomes the property of European Home.

Nothing in the above shall be deemed to imply that this warranty shall apply to work which has been abused, or neglected or shows evidence of changes or modifications by others with or without permit, damages caused by the acts of God, building settlement or moving, fire or vandalism. In addition, installation of this product that varies from the requirements stated in the instruction manual will void the warranty.

European Home is a division of Europa Ja, Inc.



# APPENDIX B

## PRODUCT INSTALLATION RECORD

Installer: Please complete this form.

Customer: Please retain this information.

Purchased From	
Date of Purchase	
Installed By	
Date of Installation	
Serial Number	
Fuel Type	NATURAL GAS

# APPENDIX C

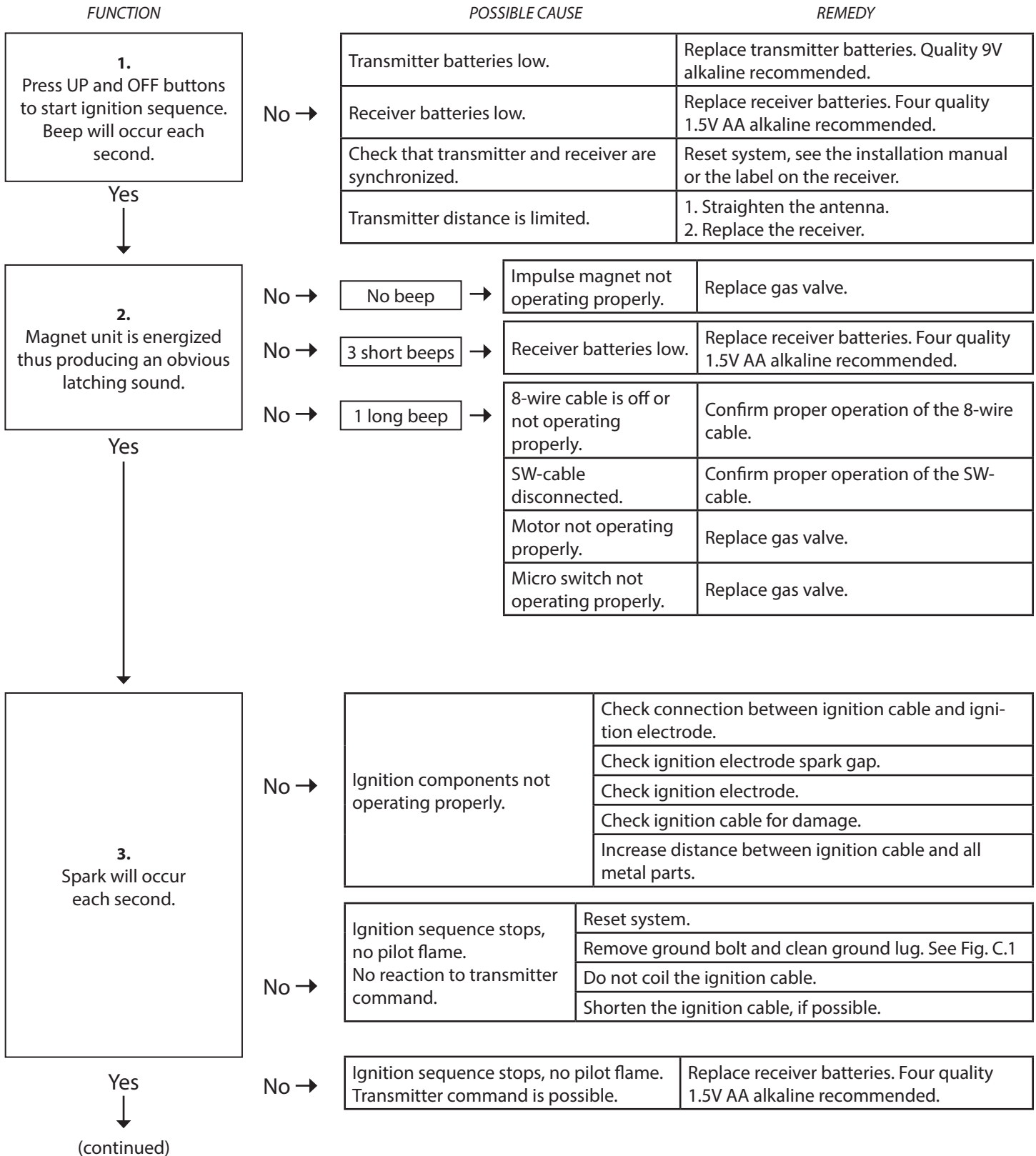

# APPENDIX C

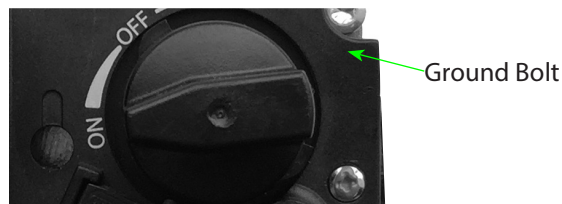
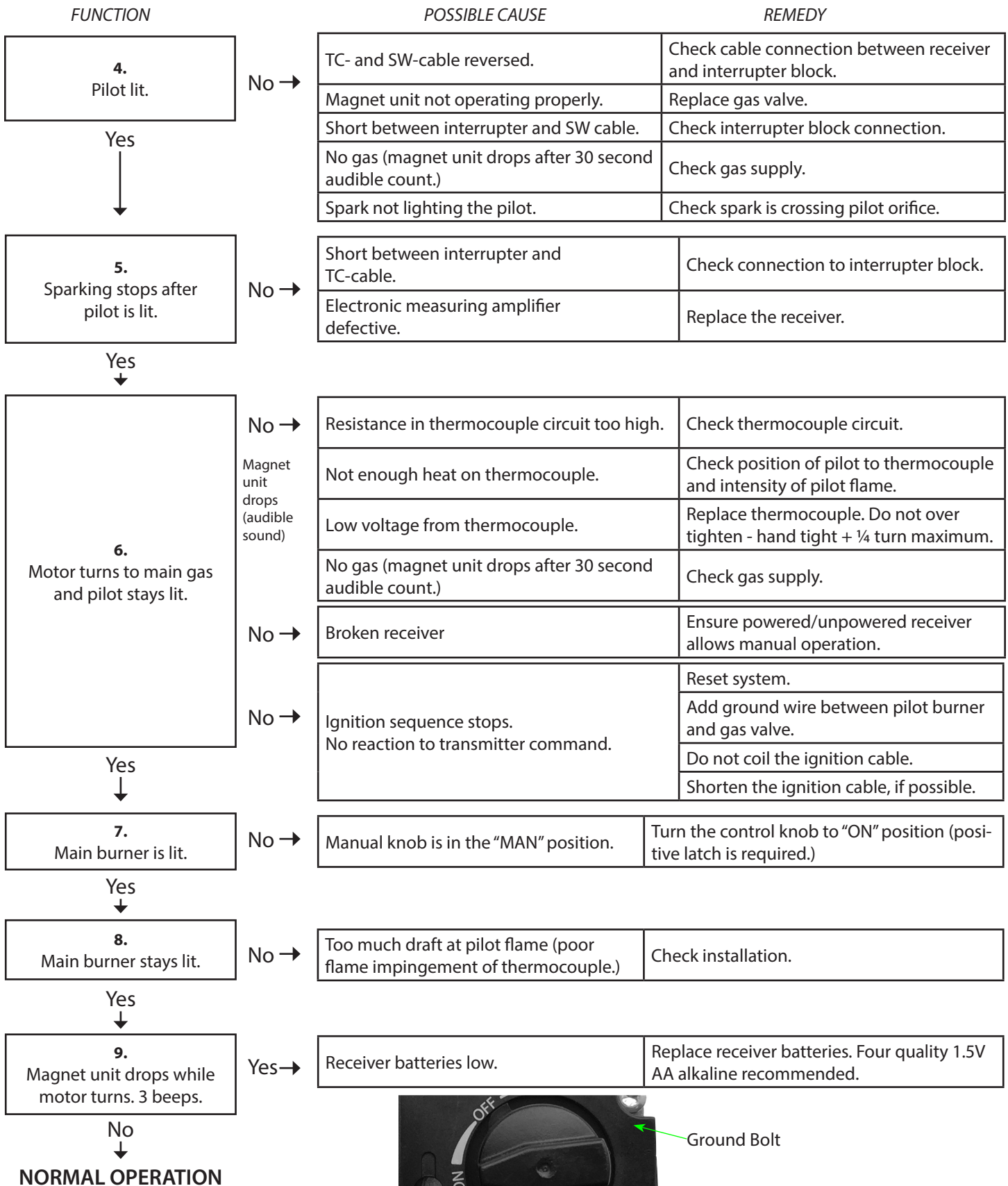

Figure C.1



EuropeanHome

**EUROPEAN HOME**

a division of Europa Ja, Inc.

30 Log Bridge Road

Building 300 - Suite 303

Middleton, MA 01949

[www.europeanhome.com](http://www.europeanhome.com)



IGGVF-20170726

Rev. B